

- 1. Stationary Roller for the Top Track
- 2. Fixator
- 3. Screws
- 4. Cable

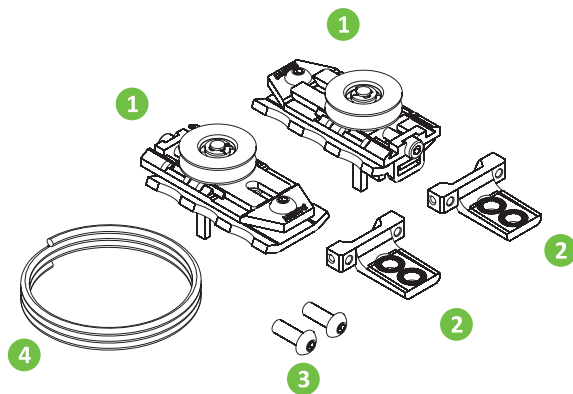

Installation Options

Two Doors - Together with Fixed Partitions



Two Doors, Overlapping Opening



- 1 Install the Fixators on the Doors.

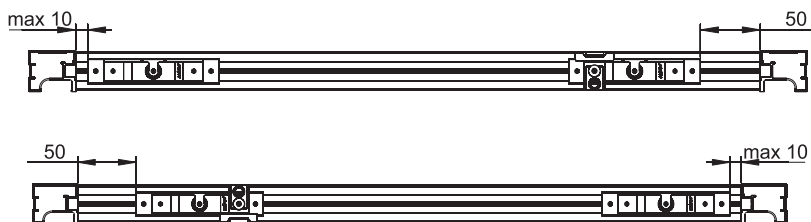
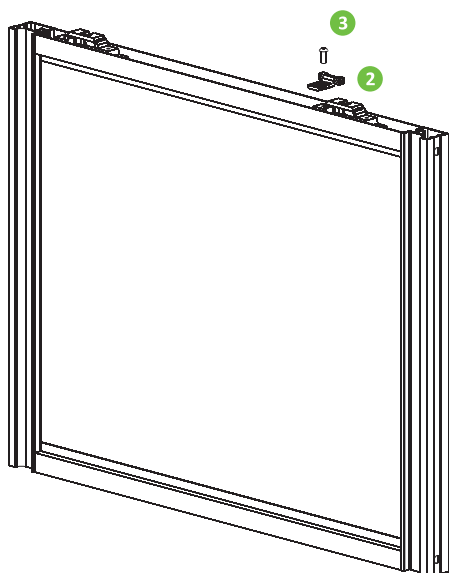

- 2 Insert other fittings into the top track.

Doors Without Soft Closing

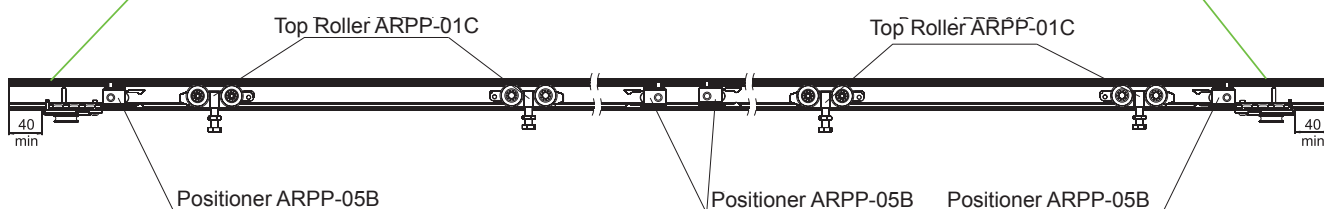
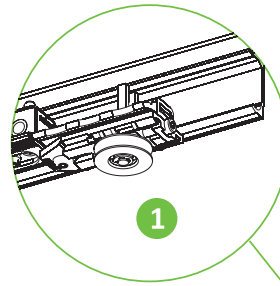
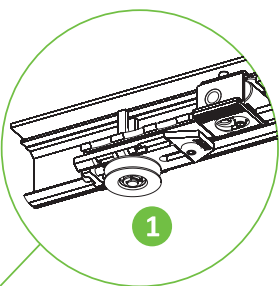

## Doors With Soft Closing

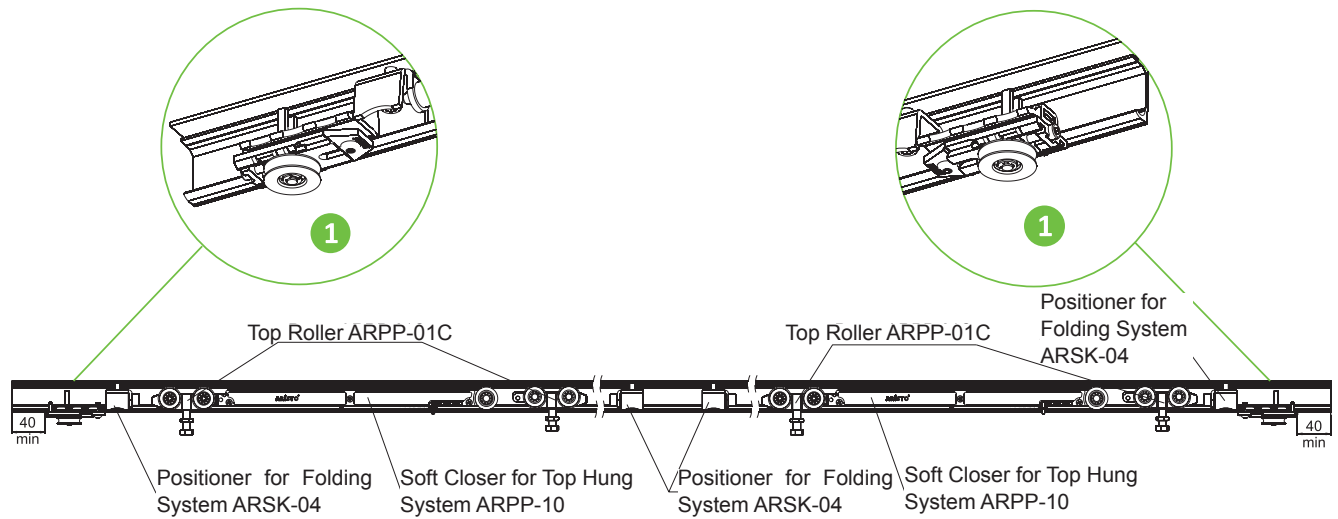

- 2 Insert the doors into the tracks and adjust them. Insert the cable and fix it by turning the hexagon bolts. Adjust the Soft Closers, the Positioners and install the Top Track Cover CKRU0592.

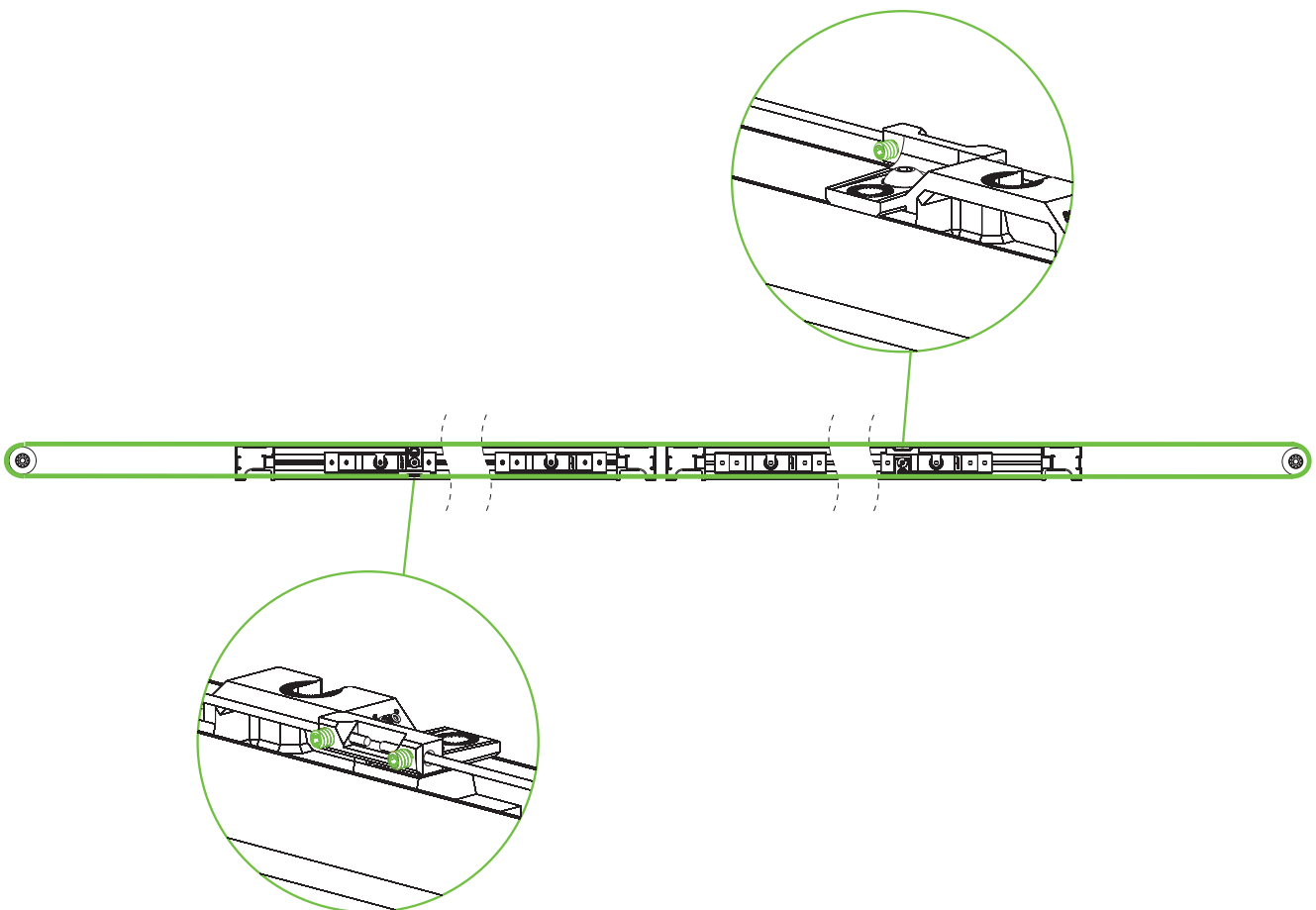

**Important:**  
The width of the door with a closer should be at least 650 mm.

**Recommendation:**  
If the door is wider than 650 mm, install one soft closer to each door. Soft closer on the left door is for opening and one on the right door is for closing the doors.  
If the total weight of the doors exceeds 80 kg, install both soft closers to close the structure.